

Glass Push-button

HmIP-WGS, HmIP-WGS-A

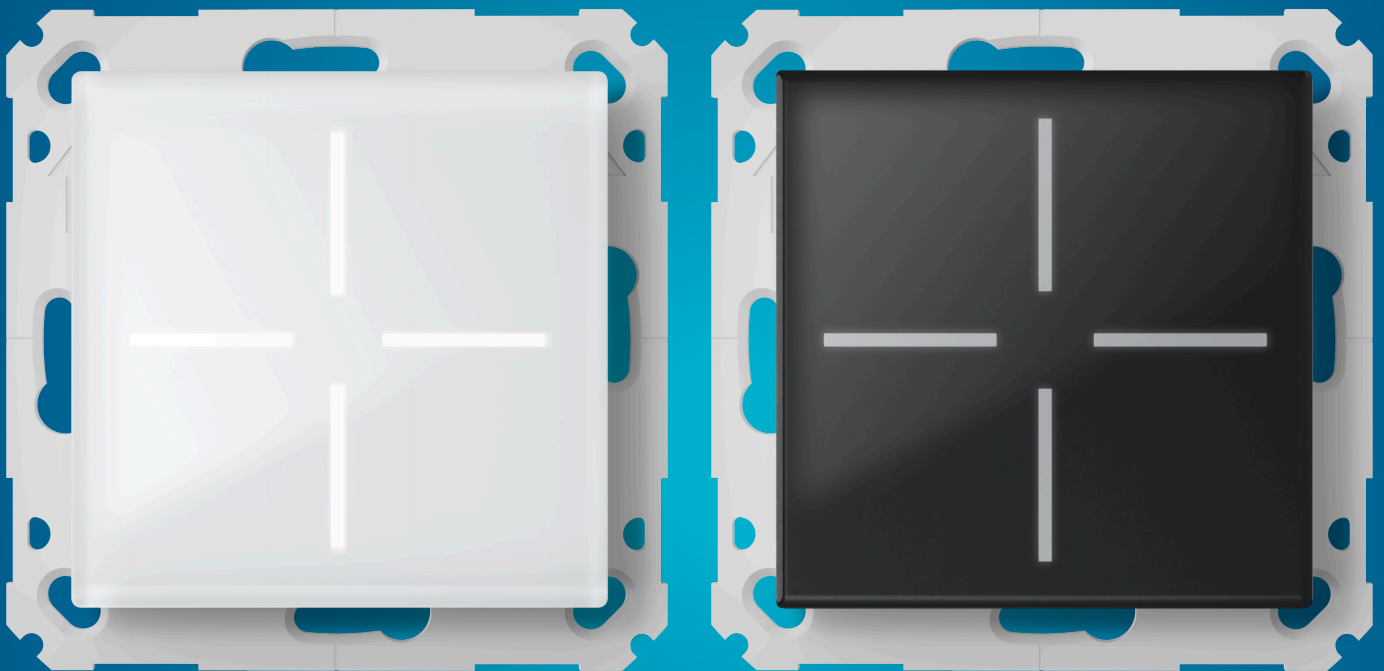

Table of contents

1 Package contents.....	3
2 Information about this manual.....	3
3 Hazard information.....	3
4 General system information.....	5
5 Function and device overview.....	5
6 Start-up.....	5
6.1 Installation instructions.....	5
6.2 Installation.....	6
6.3 Pairing with a control unit.....	7
7 Operation.....	8
8 Troubleshooting.....	9
8.1 Command not confirmed.....	9
8.2 Duty cycle.....	9
8.3 Flash codes.....	10
9 Restoring factory settings.....	11
10 Maintenance and cleaning.....	11
11 General information about wireless operation.....	11
12 Disposal.....	12
13 Technical specifications.....	13

Documentation © 03/2025 eQ-3 AG, Germany

All rights reserved. No part of this manual may be reproduced in any form or duplicated or processed using electronic, mechanical or chemical processes without the written consent of the publisher.

It is possible that this manual may contain typographical errors or printing errors. However, the information contained in this manual is reviewed on a regular basis and any necessary corrections will be implemented in the next edition. We accept no liability for technical or typographical errors or the consequences thereof. All trademarks and industrial property rights are acknowledged.

Changes in line with technical progress may be made without prior notice.

Version 3.1

1 Package contents

- 1x Glass Push-button
- 1x Mounting module with relay
- 2x Screws 3,2 x 15 mm
- Screws 3,2 x 25 mm
- 1x Operating manual

2 Information about this manual

Read this manual carefully before beginning operation with your Homematic IP device. Keep the manual for later consultation. If you hand the device over to other persons for use, please ask them to read this manual.

Symbols used

 This indicates a hazard.

 This section contains important additional information.

3 Hazard information

 We accept no liability for damage caused by use for other than the intended purpose, incorrect handling or failure to observe the hazard warnings. In such cases, all warranty claims are void. We accept no liability for consequential damage.

 Do not use the device if it has visible damage or a malfunction. If you have any doubts, have the device checked by a qualified expert.

 For safety and licensing reasons (CE), unauthorised conversions to and/or modification of the device are not permitted.









 The device is not a toy – do not allow children to play with it.

 Plastic film, plastic bags, polystyrene parts, etc. can be dangerous for children. Keep the packaging material out of the reach of children and dispose of it immediately.

 Clean the device using a soft and clean lint-free cloth. Do not use any detergents containing solvents for cleaning purposes.

 Do not expose the device to moisture, vibrations, constant solar or other heat radiation, excessive cold or mechanical loads. The device must only be operated indoors.

 Improper use of the device with a load greater than the specified rated current or greater than the specified rated power (overload) will cause the device to switch off automatically after a short delay. The safety switch-off is indicated by an error message in the app. In the event of a fault, contact a qualified electrician to have the overload rectified. The device is automatically ready for operation again after a waiting time of approx. 30 minutes.

-  Overloading the device can lead to the destruction of the device, to a fire or to an electrical accident. Before connecting a load, check the technical data, in particular the maximum permissible connected load and the type of load to be connected (load types) in accordance with the instructions. Load the device only up to the specified power limit.
-  Loads connected to the output terminals require sufficient insulation.
-  The device may only be installed in the following device boxes:
- in commercially available switch sockets (device boxes) in accordance with DIN 49073-1
 - In Legrand Batibox switch boxes
-   Failure to observe the installation instructions may result in fire or a danger of electric shock. The device is part of the building installation. Observe the relevant national standards and directives during planning and installation.
-  The device may only be operated on a 230 V~/50 Hz AC mains power supply. Work on the 230 V mains may only be carried out by a qualified electrician (in accordance with VDE 0100).
-  Observe the permissible cable types and conductor cross sections when connecting to the device terminals.
-  The circuit to which the device is connected must be protected by a circuit breaker in accordance with DIN EN 60898-1 (tripping characteristic B or C, max. 16 A rated current, min. 6 kA interrupting rating, energy limiting class 3). The installation regulations in accordance with VDE 0100 and HD384 or IEC 60364 must be observed. The circuit breaker must be easily accessible to the user and marked as the disconnecting device for the actuator.
-  The device is suitable for use only in residential environments.

4 General system information

This device is part of the Homematic IP Smart Home System and communicates via the Homematic IP Wireless protocol. All devices in the system can be conveniently and individually configured via the Homematic IP App. Operation requires connection to a Homematic IP Access Point or a Central Control Unit. Further information about the system and how to combine it with other Homematic IP devices is to be found in the Homematic IP *User guide*.

All technical documents and updates are to be found at www.homematic-ip.com.

5 Function and device overview

The Homematic IP Glass Push-button is a 4-channel glass push-button with touch surfaces that can be integrated perfectly into your living environment thanks to its contemporary design and 55 mm frame dimensions. You can configure the glass push-button as either a 1-, 2- or 4 channel button. The control panels are separated visually from each other by light strips in accordance with how you have configured the Glass Push-button.

The Homematic IP Mounting Module with switching output (HmIP-MMR), installed in a switch box, is used as the base for the Glass Push-button. The mounting module also has a relay output and an extension input for setting up button circuits, for example.

Device overview

- A) Touch surface
- B) Frame (available separately)

- C) Connecting terminal for 1 (lamp/ correspondent (normally open))
- D) Connecting terminal for L (phase conductor)
- E) Connecting terminal for N (neutral conductor)
- F) Connection terminal for S1 (extension unit input)
- G) System button (device LED)

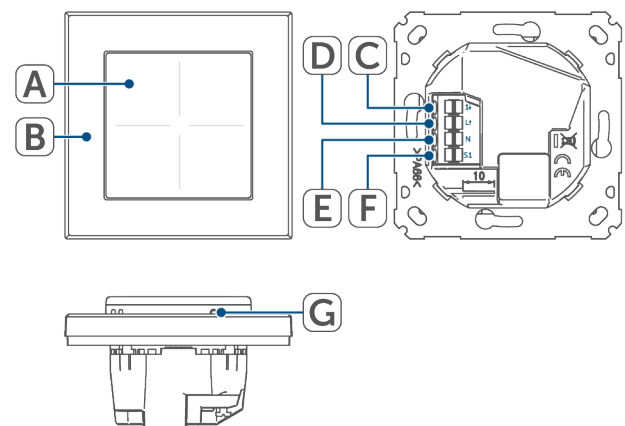







Figure 3

6 Start-up

6.1 Installation instructions

-  Read this section completely before starting installation.
-  Make a note of the device number (SGTIN) and the installation location of the device before installation to make it easier to identify the device later. The device number can also be found on the enclosed QR code sticker.
-  Please observe the hazard warnings during installation *see (Hazard information), page 3*.

 Please note the insulation stripping length of the conductor being connected, as indicated on the device.

 The installation may only be carried out in commercially available switch boxes (device boxes) in accordance with DIN 49073-1 or Legrand Bati-box switch boxes.

If changes to or work on the house installation are necessary (e.g. extension, bypass of switch or socket inserts) or to/ on the low-voltage distribution system for mounting or installing the device, the following safety instructions must be observed:

 The installation may only be carried out by persons with the relevant electrical engineering knowledge and experience!*

Incorrect installation can endanger

- your own life,
- and the lives of other users of the electrical system.

Incorrect installation also means that you are running the risk of serious damage to property, e.g. due to fire. You risk personal liability for personal injury and property damage.

Consult an electrician!

*Specialist knowledge required for installation:

The following specialist knowledge is particularly important during installation:

- The "5 safety rules" to be used:

- Disconnect from mains
- Secure against restart
- Check for absence of voltage
- Earth and short circuit
- Cover or cordon off neighbouring live parts
- Selection of suitable tools, measuring equipment and, if necessary, personal protective equipment;
- Evaluation of measuring results;
- Selection of electrical installation material for safeguarding shut-off conditions;
- IP protection types;
- Installation of electrical installation material;
- Type of supply network (TN system, IT system, TT system) and the resulting connection conditions (classic zero balancing, protective earthing, required additional measures, etc.).

Permitted cable cross sections for connecting to the device are:

rigid and flexible cable, 0,75 -2,5 mm²

6.2 Installation

Install the device as follows:

- Switch off the fuse of the power circuit.
- Remove the cover of your existing switch.

 Use a flat pointed object, e.g. a flat-blade screwdriver, to make disassembly easier.

- Disconnect the wiring and remove the existing switch.
 - Connect the phase conductor to connecting terminal L of the mounting module.
 - Connect the neutral conductor to connecting terminal N of the mounting module.
 - Connect the cable the lamp to connecting terminal 1 of the mounting module.
 - Optional: Connect the extension input to connection terminal S1 of the mounting module.
-
- Place the mounting module in the switch box and fasten it to the switch box using the screws supplied.
-
- Place the frame of your installation onto the mounting module.
-
- Fit the device to the mounting module by fully engaging the connecting pins in the holder provided in the mounting module.

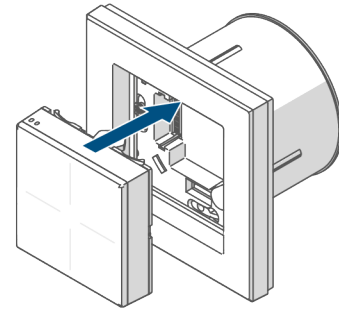

Figure 4

- Switch the fuse of the power circuit on again *see (Installation instructions), page 5* to activate the device pairing mode.

6.3 Pairing with a control unit

- i** Read this entire section before starting the pairing procedure.
- i** Set up your Homematic IP Central Control Unit via the Homematic IP App so that you can use Homematic IP devices in the system. Detailed information on this is to be found in the operating manual for the Central Control Unit..

Proceed as follows to pair the device with your control centre:

- Open the Homematic IP App.
- Tap on **...More** inn the homescreen.
- Tap on **Pair device**.
- Connect the power supply.
- The pairing mode is active for 3 minutes.

- i** You can manually start the pairing mode for another 3 minutes by pressing the system button shortly.

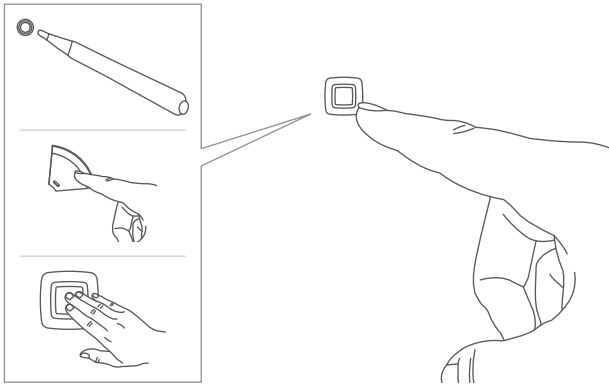

Figure 5

i The type of system button depends on your device. Further information is to be found in the device overview.

- Your device will automatically appear in the Homematic IP App.
- Enter the last four digits of the device number (SGTIN) in your app or scan the QR code. The device number can be found on the sticker supplied or attached to the device.
- Wait until pairing is completed.
- If pairing was successful, the device LED lights up green.
- The device is now ready for use.

i If the device LED lights up red to, please try again (*Flash codes*), [page 10](#).

- Finally, follow the instructions in the Homematic IP App.

7 Operation

If you have paired the device with a Homematic IP Central Control Unit, ad-

ditional configurations are available in the device settings:

- **Backlighting:** You can link and control the backlighting of the device with a time profile.
- **Buttons:** You can configure the device as a 1-channel, 2-channel or 4-channel button. The control panels are separated visually from each other by light strips in accordance with how you have configured the Glass Push-button. You can assign the push-button channels to the **climate control, light and shading** or **security** solutions. You can also configure the **Action on power supply** (on/off) for each channel.
- **Extension input:** You can specify the mode in which the extension input is to be operated.
 - Button behaviour including long button press
 - Switch behaviour when switching between open and closed
- **Quick action:** Quick action describes the simultaneous pressing of all buttons with the palm of the hand. The function is deactivated by default. Once activated, the quick action is another configurable channel in groups.

8 Troubleshooting

8.1 Command not confirmed

If at least one receiver does not confirm a command, the device LED lights up red at the end of the failed transmission process. The reason for the failed transmission may be radio interference. This may be caused by the following: [see \(General information about wireless operation\), page 11](#)

- Receiver cannot be reached.
- Receiver is unable to execute the command (load failure, mechanical blockage, etc.) or
- Receiver is faulty.

8.2 Duty cycle

The duty cycle is a legally regulated limit of the transmission time of devices in the 868 MHz range. The aim of this regulation is to safeguard the operation of all devices working in the 868 MHz range. In the 868 MHz frequency range we use, the maximum transmission time of any device is 1% of an hour (i.e. 36 seconds in an hour). Devices must cease transmission when they reach the 1% limit until this time restriction ends. Homematic IP devices are designed and produced with 100% conformity to this regulation.

During normal operation, the duty cycle is not usually reached. However, repeated and radio-intensive pairing processes mean that it may be reached in isolated instances during start-up or initial installation of a system. If the duty cycle is exceeded, this is indicated by three slow red flashes of the device LED, and may manifest itself in the device temporarily working incorrectly. The device will start

working correctly again after a short period (max. 1 hour).

8.3 Flash codes

Flash code	Meaning	Solution
1x orange and 1x green light	Test display	You can continue once the test display has stopped.
Short orange flashes (every 10 s)	Pairing mode active	Enter the last four digits of the device number (SGTIN) in your app or scan the QR code.
Short orange flashes	Transmission of configuration data	Wait until the transmission is completed.
Brief orange flashing (followed by a steady green light)	Transmission confirmed	You can continue operation.
Brief orange flashing (followed by a steady red light)	Transmission failed or duty cycle limit reached	Please try again <i>see (Command not confirmed), page 9</i> or <i>see (Duty cycle), page 9</i> .
6x long red flashes	Device defective	Please see the display on your app for error messages or contact your retailer.
Alternating long and short orange flashing	Software update (OTAU)	Wait until the update is completed.

9 Restoring factory settings

- i** The factory settings of the device can be restored. If the device is paired with a Central Control Unit, the configurations are automatically restored. If the device is not paired with a Central Control Unit, all the settings are lost.

Proceed as follows to restore the factory settings of the device:

- Press and hold the system button for 4 seconds (*Fig. 7*)
- The device LED starts flashing orange quickly.
- Release the system button.
- Press and hold the system button for 4 s.
- The device LED lights up green.
- Release the system button to finish restoring the factory settings.

The device will perform a restart.

- i** If the device LED lights up red to, please try again (*Flash codes*), *page 10*.

10 Maintenance and cleaning

- i** The device is maintenance-free for you. Leave any maintenance or repair to a specialist.

Clean the device using a soft, clean, dry and lint-free cloth. The cloth can be slightly dampened with lukewarm water to remove more stubborn marks. Do not use any detergents containing solvents for cleaning purposes. They could corrode the plastic housing and label.

11 General information about wireless operation

Radio transmission is performed on a non-exclusive transmission path, which means that there is a possibility of interference occurring. Interference can also be caused by switching operations, electrical motors or defective electrical devices.

- i** The range inside buildings can differ greatly from that in open air. Besides the transmitting power and the reception characteristics of the receiver, environmental factors such as humidity in the vicinity play an important role, as do on-site structural/screening conditions.

Declaration of conformity

eQ-3 AG, Maiburger Str. 29, 26789 Leer, Germany, hereby declares that the wireless system type Homematic IP HmIP-WGS, HmIP-WGS-A complies with Directive 2014/53/EU. The full text of the EU declaration of conformity can be found at: www.homematic-ip.com

12 Disposal



This symbol means that the device must not be disposed of as household waste, general waste, or in a yellow bin or a yellow sack. For the protection of health and the environment, you must take the product and all electronic parts included in the scope of delivery to a municipal collection point for waste electrical and electronic equipment to ensure their correct disposal. Distributors of electrical and electronic equipment must also take back waste equipment free of charge. By disposing of it separately, you are making a valuable contribution to the reuse, recycling and other methods of recovery of old devices. Please also remember that you, the end user, are responsible for deleting personal data on any waste electrical and electronic equipment before disposing of it.







The CE mark is a free trademark that is intended exclusively for the authorities and does not imply any assurance or guarantee of properties.

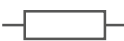

If you have any technical questions about the appliance, please contact your specialist dealer.

13 Technical specifications

Short description	HmIP-WGS, HmIP-WGS-A
Supply voltage	230 V/50 Hz
Degree of protection	IP20
Ambient temperature	5 - 35°C
Weight	110 g
Dimensions without frame (W x H x D)	HmIP-MMR: 71 x 71 x 36 mm HmIP-WGS-F: 54.5 x 54.5 x 29 mm
Current consumption	6 A
Max. switching capacity	1380 W
Standby power consumption	0.65 W
Minimum load for cross or two-way circuits	1 W
Relay	1x NO contact
Cable type and cross section	rigid and flexible cable, 0.75 - 2.5 mm ²
Installation	Only in normal commercial switch boxes (device boxes) in accordance with DIN 49073-1., Only in Batibox-type switch boxes from Legrand
Typical Open area RF range	120 m
Radio frequency band	868.0-868.6 MHz / 869.4-869.65 MHz
Duty cycle	< 1% per h / < 10% per h
Receiver category	SRD category 2
Maximum radiated power	10 dBm

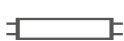
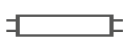
Load type		Relay
Resistive load		6 A
Light bulb test		1000 W
Self-ballasted lamps (LED/compact fluorescent lamp)		200 W
HV halogen lamps		1000 W
Electronic transformers for LV halogen lamps		1000 W
Iron core transformers for LV halogen lamps		1000 W
Fluorescent lamps (uncompensated)		1000 W
Fluorescent lamps (parallel compensated)		
Electric radiators and other electric heating systems (ohmic load)		3,5 A (200.000 Switching cycles)
Motor load		2,2 A

Subject to modifications.

Free download of the Homematic IP app!



Bevollmächtigter des Herstellers:
Manufacturer's authorised representative:

eQ-3

eQ-3 AG
Maiburger Straße 29
26789 Leer / GERMANY
www.eQ-3.de