









## SAFETY RULES

-  Do not connect the device to loads exceeding the permitted values.
-  Connect only in accordance with the diagram presented in the manual. Improper connections may be dangerous, it can damage the controller, and loss of the warranty.
-  DANGER! Risk of electric shock! Even with the device turned off, the outputs may be live. All assembly work should be ALWAYS performed with the disconnected power circuit.
-  The installation of the device to a power mains that does not meet the quality requirements defined by PN-EN 50160, will result in the loss of the warranty.
-  Warning! The absence of safety devices connected to the controller, such as infrared sensors and a sensing edge or warning signal device, can cause damage to health and property.
-  The controller connection must be carried out only by persons with the corresponding electrician's license.

1

## INSTALLATION - BASICS

- Disconnect the installation supply voltage before installing the controller. Remember that any mounting works should be carried out when the mains voltage is disconnected (switch off the mains fuse or disconnect the power cord from the mains socket).
- The controller should be installed in a place protected against adverse environmental conditions. Remember that metallic elements (wires, tubes, housing parts) have a negative influence on the range of the device, and consequently the comfort of use. The controller and electric wires must be fixed permanently to the wall. Due to the operating voltage of the device it is necessary that the wires are inserted through the rubber glands and the cable insulation is cutted-out inside the controller housing at a distance of at least 1 cm from the cable gland. When connecting the wires, make sure that the insulation along the entire length of the wire is not damaged. The correct installation must guarantee that all conductive elements are protected against accidental contacts or short circuits, which may cause an electric shock or damage to the device.
- Read the diagram and then proceed to install the controller. Remove the four screws which fix the front panel of the controller and then, holding it on both sides, pull the panel toward you, which will disconnect the strip of pins in the connector. Pay special attention to the designation of the controller connectors. Start connecting the power wires: phase L (brown), neutral N (blue) and the protective earth PE (yellow-green).

## CONNECTION DIAGRAM

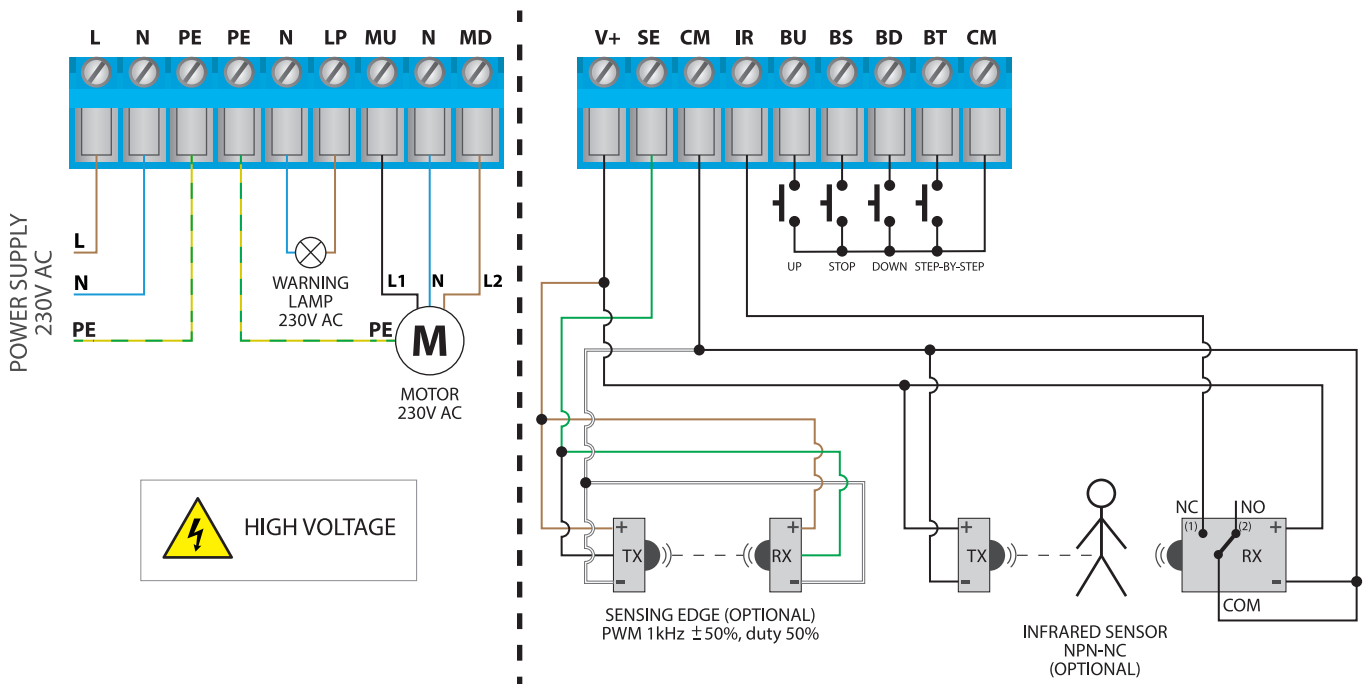

(1) without obstacle

(2) obstacle detected / sensor broken / sensor power failure

- Connect the motor wires: phase MU (black) and MD (brown), N neutral (blue) and the protective earth PE (yellow-green).
- It is also possible to connect optional accessories: a warning lamp, additional wall buttons or a wired remote controller, a sensing edge and an infrared sensor. The flashing warning lamp, supplied with a voltage of 230 V, must be connected to the terminals LP and N. The additional monostable pushbuttons must be connected between the terminal CM and, corresponding, BU ("open" button), BD ("close" button), BS ("stop" button), BT ("step-by-step" button) terminals. The optical rubber sensing edge with PWM output interface (50%@500..1500 Hz), must be connected to the terminals V+ (brown), SE (green) and CM (white). The detection of an obstacle by the sensing edge or its failure should result in the loss of the PWM signal at the SE terminal. The set of infrared beam NPN-NC sensor must be connected to terminals V+ (power "+" of infrared sensor), CM (power "GND" of infrared sensor) and IR (normally closed IR sensor output). The detection of an obstacle by the infrared sensor or the failure of the photocells (e.g. due to the damaged wire of the photocell) should cause a break in the IR-CM circuit.
- Remove the pinhead from the front panel (if it is in a socket) and insert it into the socket in the controller board. Holding the front panel of the controller on both sides, place it carefully and gently to the controller housing, paying attention to the correct insertion of the pinheads to the socket. Pay attention that the pins does not move horizontally during the assembly of the panel. Tighten gently the four screws that secure the front panel - take care not to use too much force which could damage the housing.
- After making sure that the device is connected in accordance with the diagram, power on the device by connecting the power (turning on the mains fuse or connecting the power cord to the power outlet).

## 2

### FIRST START

- Download the **free wBox application**. If you have an Android mobile device, you will find the application in the Play Store. For iOS devices the application is in the App Store.
- By using your mobile phone or tablet, connect it to the device wireless network. To do this, enter to your smartphone or tablet settings, then go to setting of the WiFi network and find the network name „rollerGate-xxxxxxx“ where xxxxxxxx is the serial number of the device. Connect to this network.
- Turn on the wBox application. A device will appear at the top of the screen. To add it to the application, click on "+" on the right side of the name. To pre-configure the controller, click on the default device name.



You can also set the configuration using the web browser of your phone / tablet. After connecting to the wireless network of the controller, turn on the browser and go website [www.blebox.eu](http://www.blebox.eu)

- Go to "Settings" (icon in the upper right corner of the screen) to the "Door security settings" section. Set the appropriate values in the fields "Enable infrared sensors" and "Enable sensing edge" according to the connected safety devices. Remember that the absence of safety devices connected to the controller, such as infrared sensors and a sensing edge or warning signal device, can cause damage to health and property! Save the configuration by pressing the "Save" button.
- Check the operation of the controller by pressing the up and down button on the keyboard panel: the controller will illuminate the panel and the roller door will begin to move. Stop the door by pressing the center button on the keyboard panel. If the door moves in the opposite direction to the one given, go to the configuration in the "Door" section and select "Yes" in the option "Change the movement direction". Remember to save the configuration by clicking on the "Save" button. Press the buttons on the keyboard panel to check again if the door moves as expected.

- If the controlled door has a motor with mechanical limit switches or with electronic limit switches, it is recommended to calibrate the controller by clicking on the "Automatic calibration" button in the "Calibration" section. After confirming the procedure, the door will automatically rise to the upper end position, then go down to the lower end position and rise to the upper end position. Do not take any action during the calibration. To check the work of the control to a point, go to the control screen, and then move the horizontal scroll bar to the extreme and intermediate positions, verify that the door moves to the position set in the animation. You can also set the partial opening position of the door (called ventilation function). To do this, go to the configuration of the "Door" section, select the option "Enable partial opening" and, in the "Partial opening position" field, enter the value from the range 0-100. By clicking on the "Test" and "Move to" buttons, the door should move in the desired position. Save the configuration by pressing the "Save" button. Check the functionality: go to the control screen, move the door to the closed position and then click on the partially open door icon (the second icon on the left). The door must be placed in the previously set position (the door will not move if the current position is higher than the saved position of the ventilation function).
- If the controlled door has an unusual motor that does not pass the automatic calibration procedure, set the "Time limit in seconds" to define the maximum time the door needs to move from one end position to the other: this is the time when the controller gives voltage to the motor. It is not recommended to deactivate the movement time limit. In the case that the automatic calibration has been carried out, the suggested value can be left.
- Familiarize yourself with the control screen: the clicking on the door icon located in the center will cause the following action in the diagram: raise, stop, down, stop. If the door is calibrated, the border around it shows the current position: the total filling with blue color means the closed position, the total filling with grey shows the open position. Under the door icon, will be displayed messages about the current status of the door, including messages from the security system. Lower is the scroll bar to set the intermediate position of the door, which is active only when the door has been calibrated. At the bottom of the screen are the control buttons, from left to right: close, partial open, stop and open. Under the buttons, is displayed an additional warning for emergency situations, for example, the detection of an object through the infrared sensor or the activation of the sensing edge.

## 3

### ACCESS POINT AND WIFI NETWORK SETTINGS

- Once you turn on the controller for the first time, you can proceed to its further configuration. Being connected to the WiFi network emitted by the device, in the control panel of the wBox application select the device, then go to "Settings" (icon at the top-right corner of the screen).
- You can change the name of the device that is displayed in the wBox application. In addition, you can change the name and password of its generated WiFi network. Remember that changing the network name or password will disconnect the device immediately after you click the "Save" button, so re-connect to the device using the newly assigned network name and password.
- You can add the controller to your home WiFi network to control it through this home network or from anywhere in the World. To do this, in the "Connect" settings section, select a network name from the list and press "Connect". If is required, enter the WiFi network password. During the connection of the controller to your home network, the phone / tablet may disconnected from the network. In this case, you will need to reconnect your phone / tablet to the controller network.
- Please remember that in order to control the device outside the local WiFi network, from anyplace in the World by using the wBox application, the option "Remote access enabled" in the controller settings must be set to "Yes".
- Once you've finished configuring the WiFi network, you can disconnect your phone/tablet from the controller network and connect your mobile device directly to your home WiFi network. The control from the wBox application will work the same way as when the phone / tablet is connected to the controller network. If the user leaves the local network, for example, leaving home or using the mobile data, the wBox application will signal this state as "Remote mode". In this case, the devices can be controlled, but for security reasons settings are not available.



TECHNICAL SPECIFICATIONS	
supply, energy consumption	230V AC, < 1W
control outputs	2 x relay, push-pull, NO; 5A/1250 VA
signaling outputs	1 x relay, NO 5A/1250 VA
control inputs	4 x logical, pushbutton, short circuited to COM, 12-24V DC, galvanically separated
supported switches	monostable (push-button), not-illuminated
safety inputs	1x logical input of the NPN-NC, 12-24V DC, galvanically separated, 1x infrared sensor, PWM signal input of the optical sensing edge with frequency 1kHz ± 50% and 50% duty, 12-24V DC, galvanically separated
supply for safety devices	15V DC / max. 1,2W
control keyboard	3- push button, capacitive (touch), illuminated, integrated in the front panel
housing	IP44, surface junction box, controller covered with a polyurethane composition not containing halogens, self-extinguishing for thermal class B (130 °C)
dimensions	129 x 89 x 57 mm
transmission type	bi-directional, encrypted
communication standard	µWiFi, compatible with WiFi, 802.11g
mode	direct connection (as Access Point), Wi-Fi connection via a standard router, connection with access from any location in the world (requires only access to the Internet)
compatible devices and systems	Apple iPhone, Apple iPad, iPad Mini, Android, computers and mobile devices supporting HTML5
controller operating temperature	from -20 to + 50°C

## ADDITIONAL INFORMATION

### SOFTWARE UPDATE

To update the software in the controller, connect it to your home WiFi network (see "Access Point and WiFi Network Settings" section) which is connected to the Internet. Go to "Settings" (icon at the top-right corner of the screen) and click the "Get new firmware" button in the final section on settings. Wait about 1 minute, do not close the interface and don't perform other actions. The device will download the latest software. The software version number, hardware version and device identifier can be read at the bottom of the settings screen.

for more information  
visit our website

[www.blebox.eu](http://www.blebox.eu)

or send us an email to:  
info@blebox.eu

support is available at  
support@blebox.eu

made in europe



proudly made by

